

by the U.S. Navy (1951)

Magnetic Amplifiers

another lost technology

edited by
George Trinkaus



I had always believed that first came the vacuum tube, then the transistor, period. But, thanks to an old Navy tech manual sent in by a reader, I've discovered a third "lost" entity. Electronics engineers of the 1950's believed the rugged little magnetic amplifier was going to replace the fragile vacuum tube in all its functions under a megacycle. Originating in the USA but adopted and developed by the Nazis for the V2 missile, the mag amp after WWII found a clique of boosters among US electronics engineers. This document, unusually

passionate and well written for a military tech manual, is their promotional brochure. Evident today only in some motor-control and power-supply regulator circuits, the mag amp not only can regulate but can magnify, oscillate, modulate, switch, pulse-generate, invert, convert, multivibrate, phase shift, and multiply. Mag amps require almost zero maintenance, can be made indestructible, and can handle up to 175,000 amperes. This rare book has been completely reset and redesigned for economy and readability. 43 illustrations. - G.T.

Copyright © 2000 by George B. Trinkaus. All rights reserved in respect to this publication's particular design elements. The rest is in the public domain.

High Voltage Press

ISBN 0-9709618-5-5

This booklet contains the text and illustrations of ***Magnetic Amplifiers***
A Rising Star in Naval Electronics
Prepared by
Electronics Design and Development Division,
Bureau of Ships, Dept. of the U.S. Navy
1951

The **Bibliography** is published separately by High Voltage Press.

Thanks to Clyde Lofton for informing me of the existence of *Magnetic Amplifiers* and for sending in a partial xerox. Thanks to the Library of Portland State University, which (miraculously) had a pristine copy in its stacks. Thanks also to D.W. French, whom Mr. Lofton acknowledged as his source for this rare document.

Contents

1. Introduction.....	1
2. Fundamentals.....	3
3. Regulators.....	10
4. Audio.....	12
5. High Frequency and Radio.....	14
6. Applications.....	19

Admiral Wallin's Preface

Magnetic Amplifiers (NavShips 900,172) is an unclassified publication which describes "an old device in a new suit." The device is the saturable core and the new suit is the core's use in electrical and electronic applications.

This material is published to encourage the use of the device in electrical and electronic applications where reliability of performance is the prime consideration. A review of machinery application principles is included as an aid toward understanding the general principles of the device.

H.N. Wallin
Rear Admiral, USN
Chief of Bureau
August, 1, 1951

Design Engineers Please Note

This publication is not intended as an engineering manual. Mathematics and detailed circuitry were deliberately removed to simplify the presentation in a form easily assimilated by busy engineers who often do not have the time to study the more detailed technical papers previously presented on this subject.

1. Introduction

Naval electronics engineers are beginning to accept the fact that a competitor to the electron tube, in the power and control field, has not only penetrated their domain but is here to stay. When first confronted with this device, they simply ignored it as being an impostor, too slow, cumbersome and inefficient to be taken seriously. Even when it started to strut in a new cloak of self-saturation and promoted itself to the rank of magnetic amplifier, it was still ignored by American electronic engineers. The device finally gave up in disgust and proceeded to Germany for physical reconditioning and a post-graduate course in social education.

The electrical-machinery people early visualized the advantages of the device as attested by the almost universal application of this static control for rotating equipment.

Electronics engineers are now forced to concede recognition of the magnetic amplifier, as it has demonstrated its value beyond question in many fields previously dominated by electron tubes.

The significance of this development in relation to Naval engineering is better appreciated when it is realized that this component is applicable to almost everything that rotates or moves on a fighting ship: throttle controls on the main engines; speed, frequency, voltage, current and temperature controls on auxiliary equipment; fire-control, servo mechanisms and stabilizers for guns;

radar and sonar equipment; pulse-forming, sweep multivibrator circuits for radar, loran, and transponder equipment; and computers, and course-and-speed plotters to verify the results.

The device is ideally suited to submarine and aircraft equipment because of the extreme voltage fluctuations of the prime power sources. Numerous countries have contributed to its evolution.

history

The magnetic amplifier is not new; the principles of the saturable-core control were used in electrical machinery as early as 1888 although they were not identified as such.

Saturable-core devices have been used, principally in heavy electrical machinery, in the U.S. since 1900. The U.S. Navy has been using them to a limited extent mostly as static control instruments in rotating equipment during the past eight years. Development beyond this perimeter into the electronic field has been retarded in the U.S. primarily due to the reluctance of our engineers to experiment with a new device, especially in view of the excellent performance experienced with current electron tube equipment.

Many engineers are under the impression that the Germans invented the magnetic amplifier. Actually it is an American invention. The Germans simply took our comparatively crude device, improved the efficiency and response time, reduced weight and bulk, broadened its

magnetic amplifiers

field of application, and handed it back to us.

It was mainly the improvement in processing magnetic material and the introduction of selenium rectifiers that led to the wide use of magnetic amplifiers by the Germans.

The German navy used the device in its master gun stabilizers. Their air force used it in automatic pilot and ground-approach systems. They also used it in servo and frequency-control systems for long-range rockets, blind landing aids, and to regulate the fuel flow in relation to atmospheric and ram pressure in some types of guided missiles. They also applied the device as cathode followers, replacing electron tubes in computer circuits. The German army had started to apply it to the V-2 rocket stabilizer and steering system.

German civil interests were also quick to visualize the advantages of this device. They had started to apply it to computing machines, electric brakes for trucks and locomotives, high voltage power lines (controlling up to 50,000 KVA), a.c. streetcar controls and other miscellaneous uses.

The fact that the Germans introduced the device into fields previously dominated by electron tubes is considered by many to be of as great importance as the technical development of the device.

Although Germany is unquestionably

responsible for the rebirth of the magnetic amplifier, other countries (especially the U.S.) held a considerably greater number of patents on this device. The efforts of Sweden, England, and Japan were also considerable.

The reason for the Nazis assigning their best scientists and expending millions on its development in the midst of a bitter war has never been definitely determined. There was no shortage of electron tubes; performance of the tube-controlled equipment certainly was not improved by the substitution.

Considering the above, the motive warranting such expenditures appears to have been an acute shortage of field electronics technical personnel, making a dependable, maintenance-free device mandatory wherever possible.

The performance of the magnetic amplifiers obviously must have equaled that of that of the electron-tube circuits as these devices were used in some very critical applications, such as stabilizers, servos, and fire-control equipment in their latest fighting ships.

It was during the last war that the U.S. Navy started to exploit the device for purposes other than power regulators. Development contracts have now expanded into the high-speed range of digital computers and pulse forming, memory and scanning applications in radio, radar and sonar equipment.

2. Fundamentals

A magnetic amplifier is simply another type of control valve. A valve in a water line can be considered an amplifier if a small stream of water operates a larger valve in the main line.

Electrically the device can be compared somewhat to that of an electron tube in that the grid of the tube controls a relatively large amount of plate power. In a magnetic amplifier, power is varied, like the water valve and the tube, by inserting the device in series with the load to be controlled. Control is then accomplished by varying this impedance, which increases or decreases the power to the load. The impedance to the flow of a.c. is effected by changing the degree of saturation with a relatively small amount of d.c., or properly phased a.c. through a separate winding on the same core. An unsaturated core has a relatively high impedance to a.c. A saturated core acts effectively as an air core, with practically no impedance except for the ohmic resistance of the copper wire.

Figure 1 illustrates the principle of operation. With the core completely within the coil the impedance to the flow of current is high, permitting possibly only a fraction of a volt to appear across the load. Pulling the core out causes this load voltage to rise progressively to practically 115. In effect, this is the operating principle of a magnetic amplifier. Since it took only a few watts of muscular

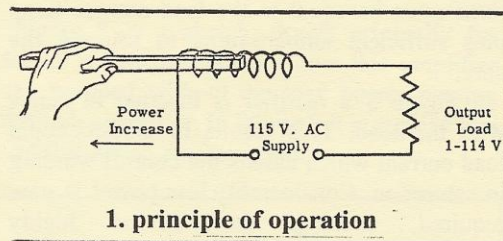

1. principle of operation

energy to move the core within the coil, which may in turn control several horsepower, the device is an amplifier. Since this is done magnetically, the device is called a magnetic amplifier.

Technically it may be described as essentially a device which controls the a.c. reactance of a coil by controlling the effective permeability of the magnetic material on which the coil is wound.

Although the sketch in Figure 1 is drawn primarily to illustrate the principles of operation, there are many applications still in use utilizing the mechanical system. The principle of control is the same. The action, however, does not completely fulfill the description in the previous paragraph "controlling the effective permeability of the magnetic material," since iron in this instance is actually replaced by air. In modern applications, the core is stationary. Its impeding effect to a.c. power is changed by varying the saturation of the iron core. This not only simplifies the installation but permits a much higher speed of response and considerably widens the range of applications.

Figure 2 is the basic circuit of saturable control. The secondary or load winding impedance is controlled by the amount of current flowing in the primary or control winding. This would be a relatively inefficient amplifier because the control winding ampere-

magnetic amplifiers

turns must be equal to the load ampere-turns plus sufficient ampere-turns to saturate the core.

In Figure 3 a rectifier is inserted in series with the load. This results in unidirectional load current which assists the control winding in saturation. Considerably less power is now required, making the device highly competitive with other types of amplifiers.

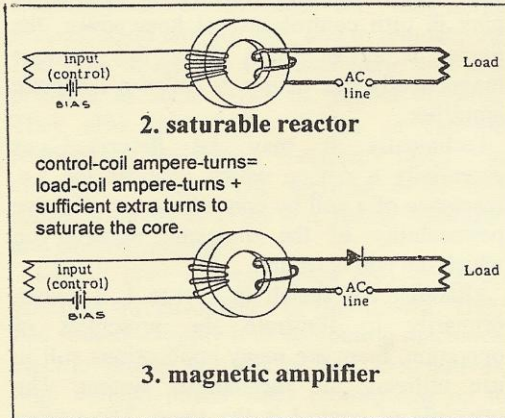

Although Figure 3 has been developed into a high gain amplifier, it is still deficient in some respects, namely:

1. The device as shown would act as a step-up transformer in reference to the load power and generate power into the control winding. This would not only be undesirable but would also result in an unnecessary power loss.
2. Due to the single rectifier, only an insufficient pulsating d.c. load power would result.

Figures 4 and 5 show a more practical design. (To simplify the sketches, cores will be taken for granted and control windings will be represented by a single turn.) With two load

coils they can be wound opposed, neutralizing any transformer effect into the control coil. The two power coils also permit utilization of both sides of the alternating current, resulting in a good waveform and efficiency. Figure 4 is the basic amplifier for a.c. loads. With the addition of two rectifiers (5), the device generates and controls a d.c. load from an a.c. supply. Three-legged cores with the control coil wound on the center leg and power coils on the outside are usually used with the above circuits in power-control applications.

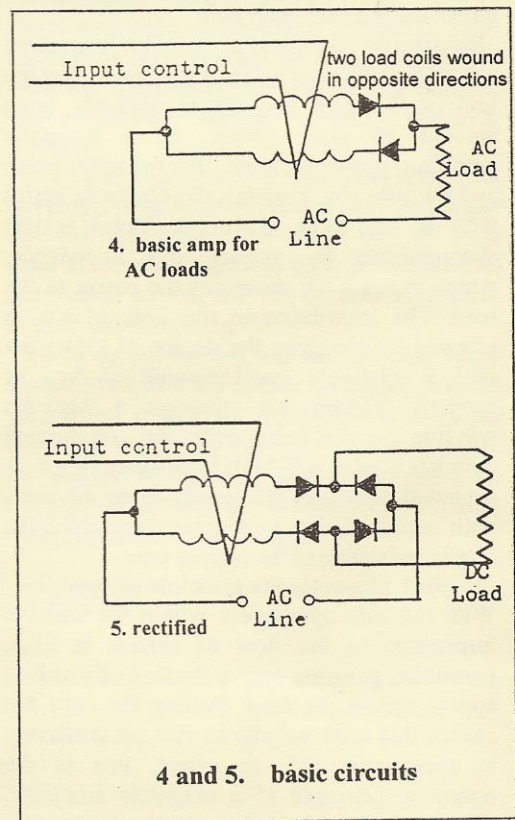

fundamentals

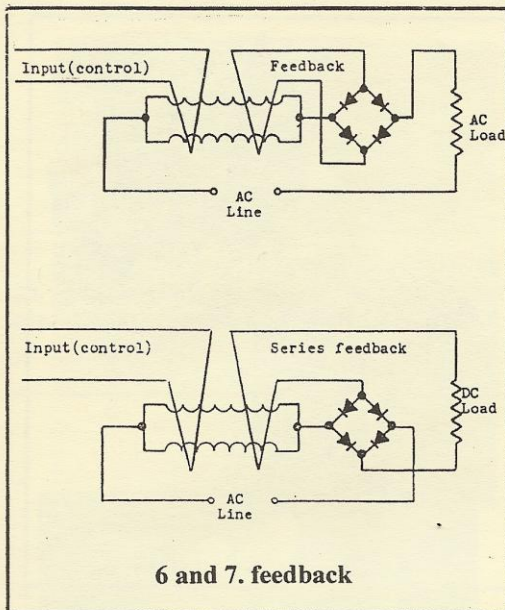

Figures 6 and 7 show further developments with the addition of feedback. Gains of up to several million per stage have been obtained with these circuits.

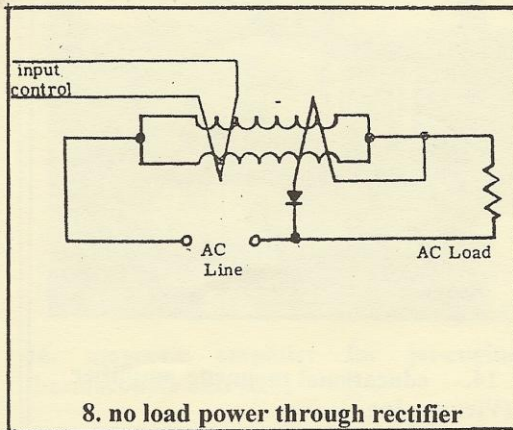
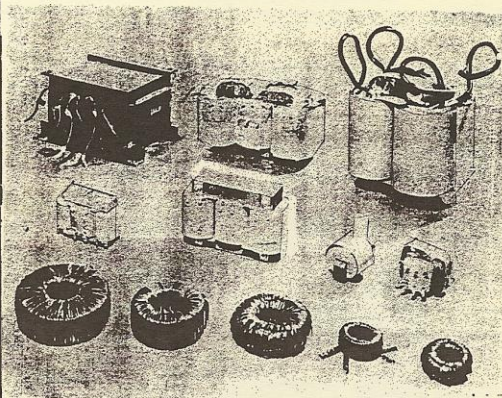
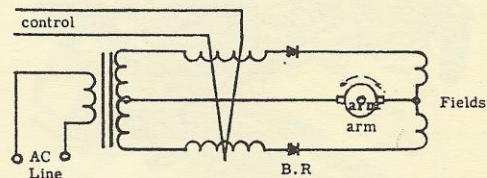

Figure 8 is a sketch, drawn originally for school purposes, showing how this amplifier can be used without the load power passing through a rectifier. In Figure 9 it is applied to a variable-speed reversing motor.



10. saturable reactors

Figure 10 shows various types of saturable reactors used for machinery-control applications. (Vickers, Inc.)

magnetic amplifiers

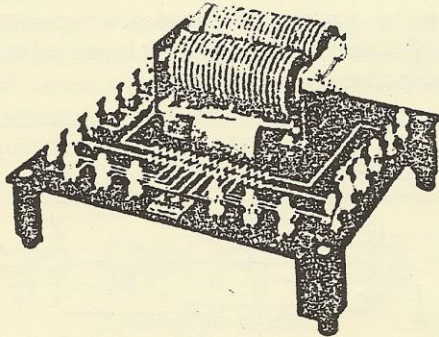

11 educational magnetic amplifier (GE)

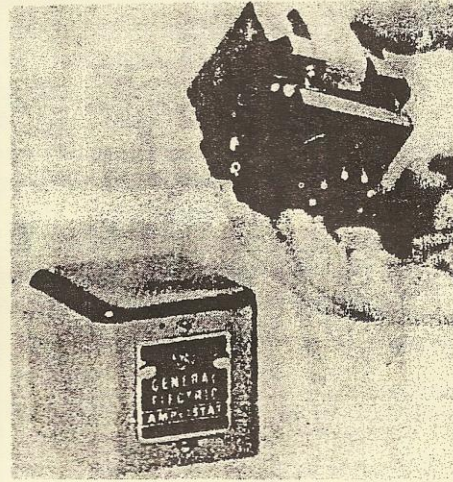

13. 60-cycle, 2-watt (GE)

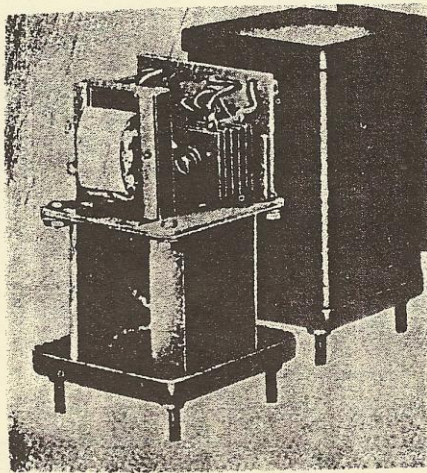

12. 400-cycle 10-watt (Mag. Amp., Inc.)

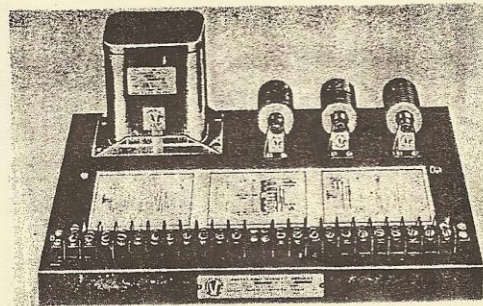

14. educational magnetic amplifier (Vickers, Inc.)

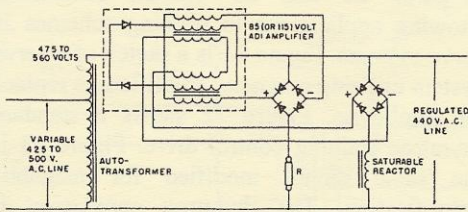

15. example of an educational amplifier experiment: voltage regulator

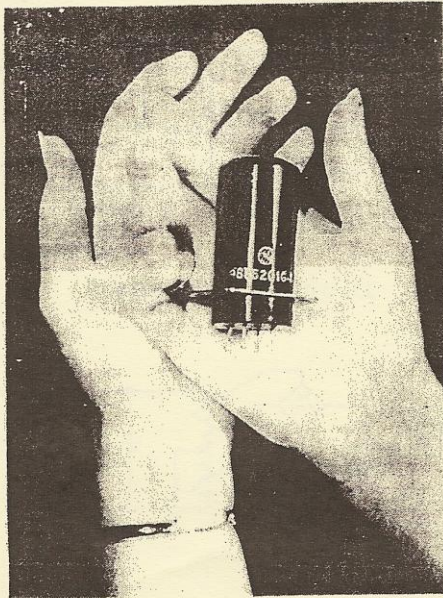

16. magnetic amplifier for jet-engine thermocouple unit (GE)

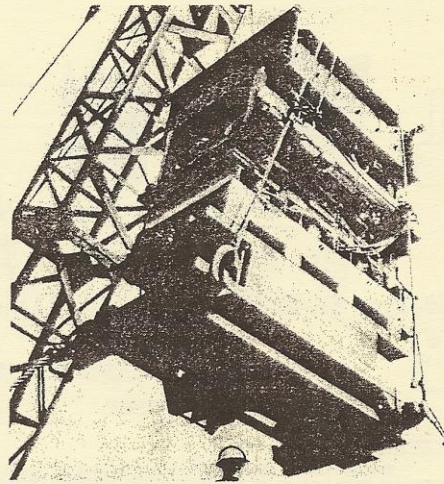

17. selenium rectifier designed for HP 175,000-amp magnetic amplifier



18. selenium rectifier designed for LP (100 Ma.) magnetic amp. (Fed. Tel & Radio Co.)

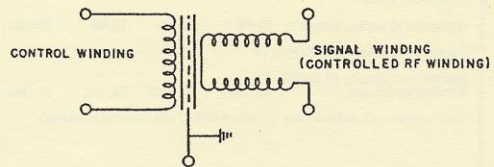

19. increductor variable inductance

magnetic amplifiers

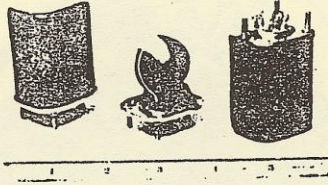

20. Type XA-B3 HF reactor (C.G.S. Labs)

TYPE XA-B3 INCREDUCTORS*

PURPOSE

The type XA-B3 INCREDUCTORS are intended for use in the frequency range between 100 kilocycles and 10 megacycles. They provide large inductance change with low control power. For typical performance, see the attached characteristics sheets.

GENERAL SPECIFICATIONS:

Mechanical Construction	See drawing
Weight	4 ounces
Dissipation Limit	2 watts
D.C. Resistance of Control Winding	250 ohms
Inductance of Control Winding at 0 Current	6 henrys
Operating Temperature Range	-40 to +65° C.
Average Temperature Coefficient of Inductance, Signal Winding	1.5% per degree C.
Minimum Available Change of Inductance, L_0/L with 1 watt control power	160 to 1
Minimum Available Change of Frequency, f_0/f with 1 watt control power	12.5 to 1

INDIVIDUAL SPECIFICATIONS:

TYPE: MODEL:	XA-B3- 25k-6k	XA-B3- 6k-6k	XA-B3- 15c-6k	XA-B3 7c-6A
Nominal Inductance for 0 Control Current, L_0	25 mh	6 mh	1.5 mh	0.7 mh
Maximum Inductance, Demagnetized State, L_d	43 mh	10 mh	2.5 mh	1.2 mh
Approximate Recommended Starting Frequency Range	100-300 kc	100-300 kc	200-600 kc	300-900 kc
Approximate Q of Starting Frequency Range	30	30	25	20
Maximum Q within Range	50-70	50-70	40-60	40-60
Current Compensating Factor	7	14	30	45
Maximum Capacity of Signal Winding to Ground	40 uuf	25 uuf	25 uuf	25 uuf

Tolerances: all values plus or minus 15% if not otherwise stated.

*Trademark
Patent Applied For.
C.G.S. Laboratories, Inc.

Stamford, Conn.

Figures 22 and 23 contain schematics showing applications to training schemes in servo systems. Figure 21 is a sketch of a servo system utilizing magnetic amplifiers to replace an amplidyne. Figure 22 shows a standard thyatron training control drive. Figure 23 is the same circuit modified for magnetic amplification. The thyatron conversion is relatively simple as most of the components designed for this tube will also match the magnetic amplifier. This conversion can almost be simplified to the extent of providing a rectifier adapter to plug into the thyatron tube sockets.

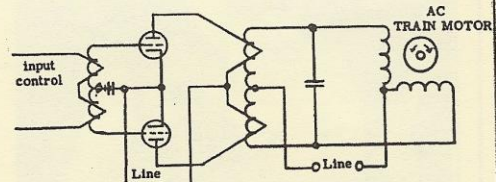

22. with thyatron control

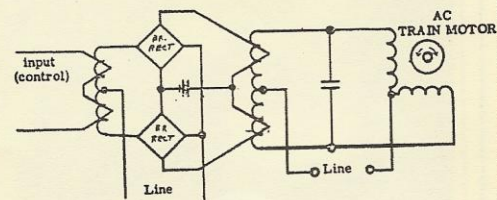

23. magnetic amp. conversion

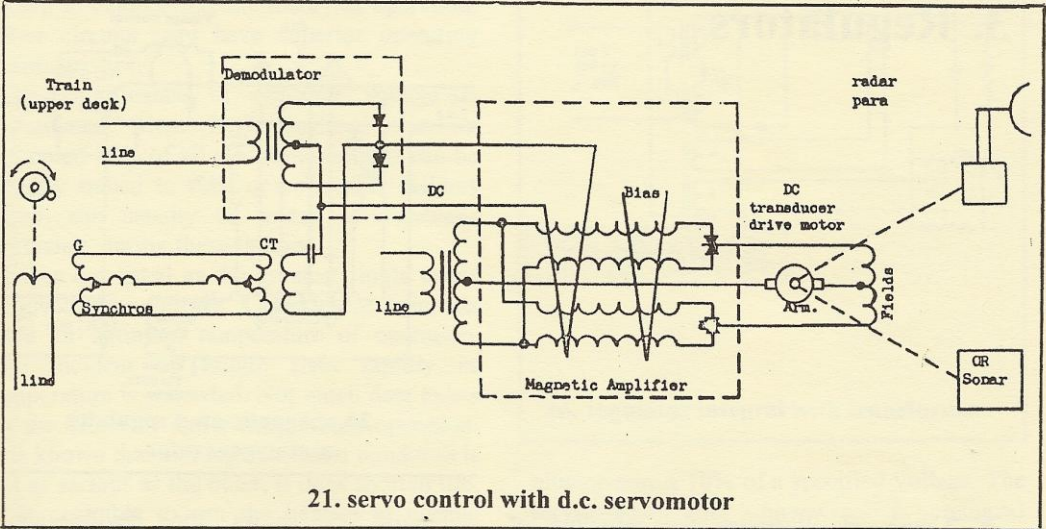

21. servo control with d.c. servomotor

3. Regulators

Figure 24 illustrates the principle of applying the magnetic amplifier to frequency and voltage controls of rotating generators. The control coils in the d.c. drive motor fields are actuated by two tuned circuits resonated at 55 and 65 cycles. The lower frequency coil is wound opposed to increase the speed of the motor. The 65-cycle coil is wound aiding to increase the d.c. field current. The reaction of the two currents maintains a constant 60-cycle output.

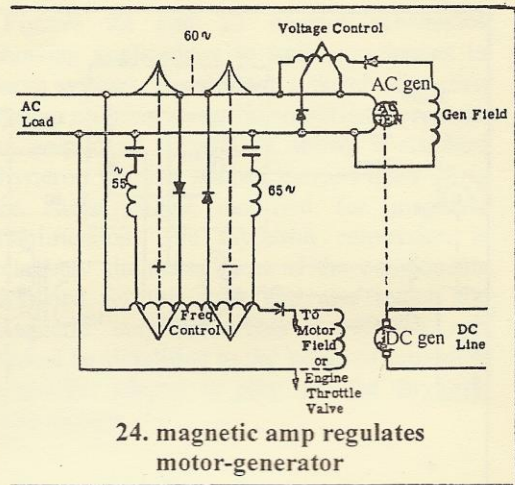

24. magnetic amp regulates motor-generator

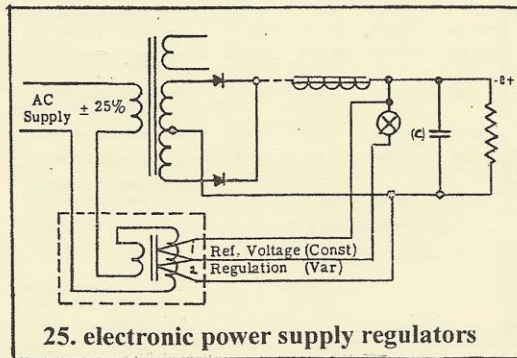

25. electronic power supply regulators

Figure 25 shows the device applied externally to transformer regulation. The component X across coil 1 indicates a nonlinear device (VR tube, Thyrite, etc.) used as a combined reference voltage across coil 1, and a current amplifier for coil 2. Two-element nonlinear devices are shown for simplicity. When a.c. is used as a voltage reference, a small saturable reactor is used for a nonlinear device, usually in a bridge connection.

Control coils 1 and 2 may also be applied to choke (L) which would effectively transfer the filter condenser C to the other side of the choke upon saturation. The condenser input effect would result in good plate voltage regulation, with Fil. unregulated.

Figure 26 shows a regulator designed integral with the equipment transformer. This system is used in a special 440-cycle type of aviation radar equipment and for portable installations where light weight is desired. Insert shows the core arrangement. The above circuits are

shown to demonstrate the theory of operation. Other circuits may have superior operating characteristics.

The significance of constant voltage is appreciated when it is realized that an estimated 80% of all electronic failures can be directly traced to tube or condenser failures which can usually be traced to overloads occurring during these failures.

Tubes are listed as the greatest single cause of electronics failures. Cathodes or filaments have an optimum temperature of operation. The incident of failure rises rapidly as temperature is exceeded. Not much data exists on the effect of under-temperature operation. It is known that although the latter condition is not as serious as the other, it does shorten life. It is desirable to run the heaters at normal ratings from regulated power supplies when long stable service is desired from tubes. Life tests on tubes operated on above normal voltages are not available. However, life tests on incandescent electric lights show the life of the filament is reduced 50% when operating on a voltage only 7% above normal.

In electron tubes a rise in line voltage also causes an increase in plate current which adds to the abuse of the already overheated filament or cathode. The additional heat generated by tube and other components within the equipment compartment causes the ambient temperature to rise, which also contributes somewhat to accelerated equipment failures.

Another point often overlooked is that once the tubes have been operated under accelerated conditions, their performance is considerably reduced when returned to normal operating voltages.

Military equipment is designed to operate

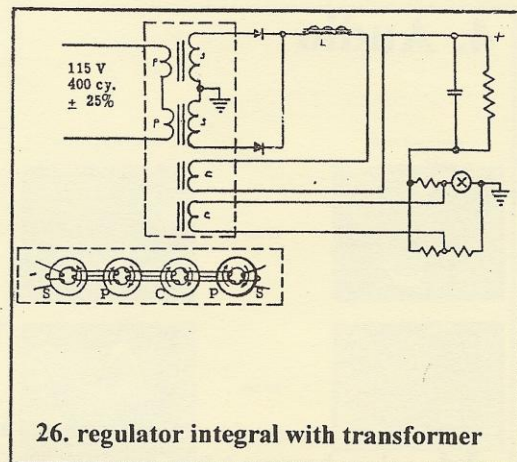

plus-or-minus 10% of a specified voltage. The service-free life, however, is reduced considerably when operating in the upper voltage range.

Normally the larger naval vessels have excellent voltage regulation. This voltage, however, is maintained to the trunk lines. The branch lines, due to intermittent loads, are difficult to regulate. This results in accumulated equipment strains, eventually ending in complete failure.

Several manufacturers can supply automatic voltage regulators as components to be inserted between the line and equipment. These are rather large, with low efficiency, and are somewhat sensitive to frequency, as most of them operate on the resonance saturation principle. Regulators should be built into the power transformer rather than supplied as a separate component. They should be made mandatory for all equipment where interruptions due to failure may be serious.

4. Audio

From an electronics angle, perhaps an analogy between a tube amplifier and a magnetic amplifier should be made. Any attempt to analyze the magnetic amplifier in relation to a tube requires that certain assumptions be made, as this amplifier differs considerably from the electron tube type. However, since the input saturation control voltage vs. load current can be made to follow almost precisely that of a tube, a theoretical analysis can be made on the straight portion of the curve.

Figures 27 and 28 are sketches of a tube and magnetic amplifier. Figure 29 is a magnetic saturation vs. impedance curve of a typical magnetic amplifier. Since this curve almost duplicates that of certain type tubes, operating characteristics of both can be plotted on the same curve. For a fair comparison the "plate" supply of both amplifiers must be a.c., as a magnetic amplifier will not control d.c. If this amplifier is to be used to amplify audio frequencies the supply frequency should be above audibility. Since both amplifiers are single-ended, they must be operated in class A, half way up the slope, as shown in curve (c), point (a).

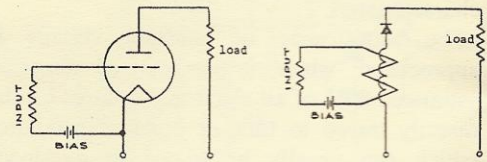

27. tube amplifier 28. magnetic amplifier

These amplifiers working in class A would not only be inefficient, but provisions would have to be made to separate the carrier from the voice frequencies. Consequently they are usually operated as push-pull, class A/B. With this connection the carrier can be point (b), biased out, as shown in Figure 30. With push-pull connection the "plate" supply rectified pulses are also doubled and smoothed out.

Figures 31 and 32 show basic sketches of more practical push-pull amplifiers. Figure 32 is a single-stage amplifier capable of gains up to several thousand. These amplifiers have been constructed with several stages in cascade with power outputs up to 500 watts with excellent linearity up to 7000 cycles.

According to two British investigators

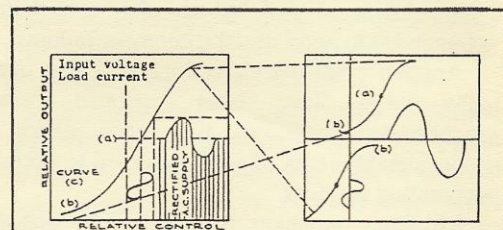

29. class A, single 30. class B, push-pull

(Williams and Noble), it is possible to amplify control signals of ten to the minus 18 watts at a bandwidth of 10 cps in a special magnetic amplifier having a basic limitation of 4×10 to the minus 20 watt due to thermal noise. Barkhausen effects in the same magnetic amplifier are equivalent to a signal input of 10 to the minus 19 watts for a bandwidth of 1 cps. Drift is the major limiting factor in low output applications.

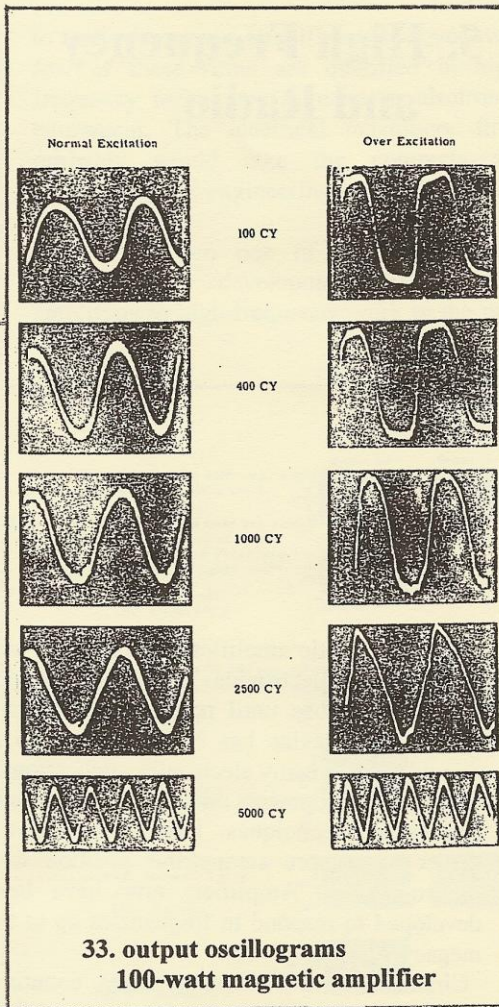
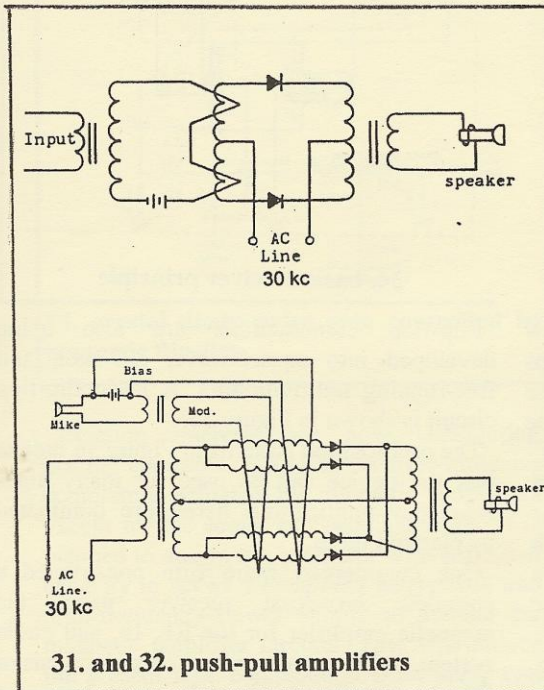

33. output oscillograms
100-watt magnetic amplifier

5. High Frequency and Radio

Magnetic amplifiers are relatively new to electronics engineers, perhaps because until recently the response time of the device has been too long to be considered for many electronics applications.

Recent developments in core materials and application techniques have elevated the device to a more competitive position with electron tubes. Amplifiers now have been developed to respond to frequencies up to the megacycle range.

Circuits for wave-shaping, gating, counting, and for pulse generators and pulse amplifiers have been designed to handle pulses up to 500,000 per second.

Magnetic flip-flop combinations are also used as frequency discriminators, band-pass switches, sharp cut-off filters, and, more recently, have been developed for sine-wave high-frequency oscillators.

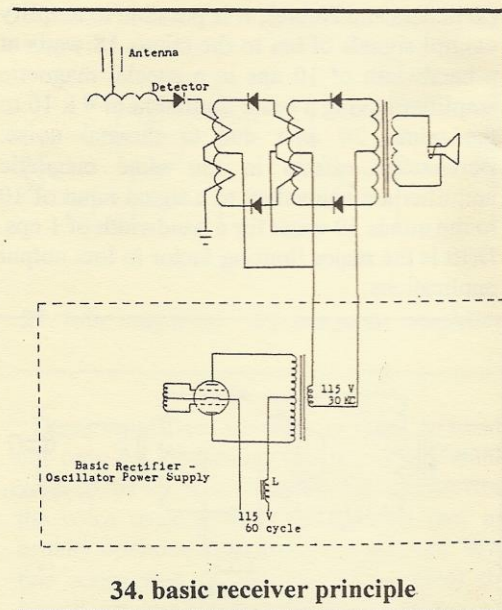

34. basic receiver principle

Flip-flop combinations are also being developed into square-wave, one-shot, and free-running multivibrators. A basic flip-flop circuit is shown in Figure 35.

The oscillograph patterns in Figure 36 indicate that the device can be used for many high-frequency applications heretofore dominated by electron tubes.

One commercial radio firm constructed a complete broadcast receiver using the magnetic amplifier for the RF, IF, and audio system, with a germanium crystal transistor for the oscillator. Crystals were used for detectors. A static magnetic converter was used as a frequency multiplier power supply. This broadcast receiver, it is understood, was constructed primarily for publicity purposes to show that a relatively intricate electronic device could be made without the use of electron tubes.

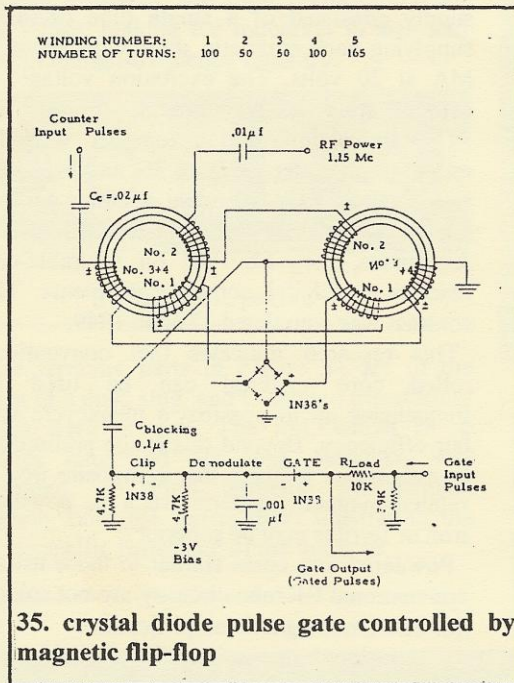

35. crystal diode pulse gate controlled by magnetic flip-flop

Aviation interests are now considering placing contracts on a loran receiver-indicator completely actuated by magnetic amplifiers except for the scope and oscillator tube. It is planned to design the oscillator with sufficient capacity to act as a *combined* heterodyne and high-frequency power supply to actuate the magnetic amplifier circuits. This will reduce the present tube complement from thirty two to two, one of which is the "picture" tube.

The weakness in the high-frequency application field is development and application know-how. There are many firms that specialize in magnetic amplifier design and development for electrical machinery such as controls, regulators, servo applications up

to audio-frequency amplifiers. However, very few of these firms are qualified in high-frequency techniques as used in electronics equipment. The electrical machinery firms probably would take the contracts and subcontract the engineering to the electronics manufacturers.

This has been one of the main factors retarding the development of magnetic amplifiers to high-frequency work in the past.

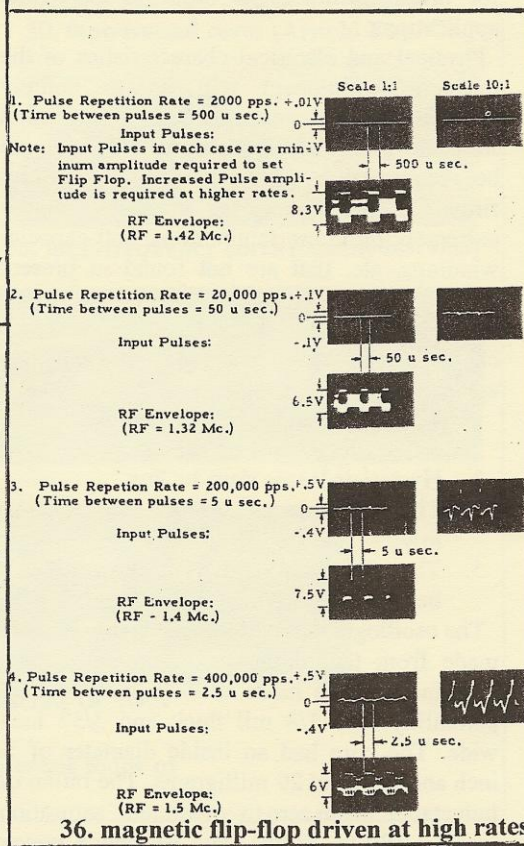

36. magnetic flip-flop driven at high rates

magnetic amplifiers

Magnetic amplifier electrical firms are not capable of applying this amplifier to the best advantage in high-frequency applications. Therefore it appears desirable that electronic equipment manufacturers be given these contracts without restrictions, to either subcontract for the magnetic components or develop the hybrid coils themselves.

Those companies who have been prominent in both the electronics equipment and the magnetic amplifier fields should be favored for initial contracts in order to accelerate applications.

Physical and electrical characteristics of the magnetic component will be so entirely different after modifications for high frequency, that they probably would not even be recognized by the machinery amplifier firms. High-frequency applications require extremely thin core laminations, anti-capacity windings, etc. that are not found in present production units.

Following are some of the core characteristics desirable for high-frequency applications:

1. The core must be easily saturable
2. Eddy effects must be at a minimum.
3. Hysteresis losses must be low.
4. The physical mass of the core must be low.
5. The effective retentivity of the core must be low.

The oscillographic patterns of Figure 36 were made from the output of Figure 35, which contained a core made of 4-79 molybdenum permalloy tape 1/8 mil thick and 3/32 inch wide. The core had an inside diameter of 1/4 inch and weighed 20 milligrams. The ration of inductance from zero to maximum saturation was 4:1 (80 to 20 uh). The RF anode power

supply consisted of a single tube oscillator supplying each magnetic stage with about 20 MA at 20 volts. The excitation voltage, of course, varied with signal input.

The above information together with the oscillograph pattern, Figure 36, and Figure 35 was obtained from a Bureau of Ships contract report as furnished by Engineering Research Associates, Inc., St. Paul on saturable-core reactors as digital computer elements. This contract was completed 17 June 1949.

This research indicates that conventional rolled core material can be used for frequencies up to possibly a megacycle with fair efficiency. Beyond this range preliminary investigations indicate that composite iron or related magnetic material such as powdered iron or ferrites may be superior.

Powdered iron cores similar to those used in conventional RF tube circuitry are not suitable for efficient magnetic amplification.

In powdered iron cores, the desirable high volume resistivity is achieved by bonding fine metal particles to some form of organic binder. This reduces the permeability and leaves the core full of air gaps which is undesirable from the standpoint of efficient saturation required for magnetic amplifiers.

The deficiencies of the powdered iron core, however, can be ignored in certain circuitry in connection with magnetic magnification such as impedance-matching coils and other specialized applications where amplification is less important. In one instance these cores were used in coils where high Q was important for selectivity which could not be achieved with other material.

Magnetic ferrites show interesting properties as magnetic core material. Consisting only of metallic oxides, this material has a high

volume resistivity and high permeability but low losses, making for reduction in size and weight in high-frequency circuitry.

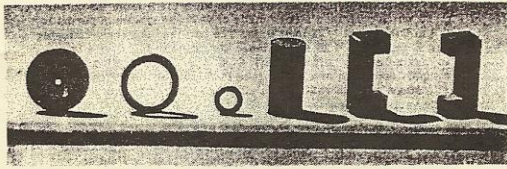

37. ferramic parts

The ferramic parts in Figure 37 are in the form of a disk, slug, and C-shaped transformer cores were pressed. The rod, which is 20 inches long and 3/8 inch diameter, was extruded. A spiral inductor was printed directly onto the ferrite disk, illustrating the high specific resistance of the material.

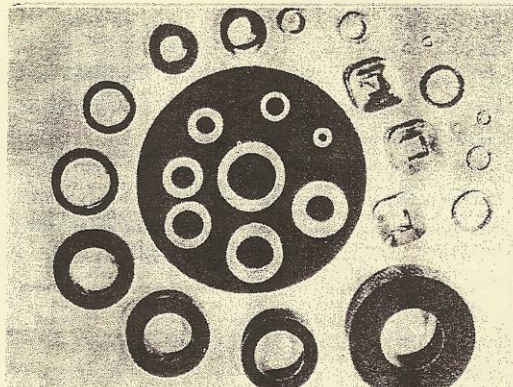

39. tape-wound cores (Arnold Eng. Co.)



40. high-frequency cores (Magnetics, Inc.)

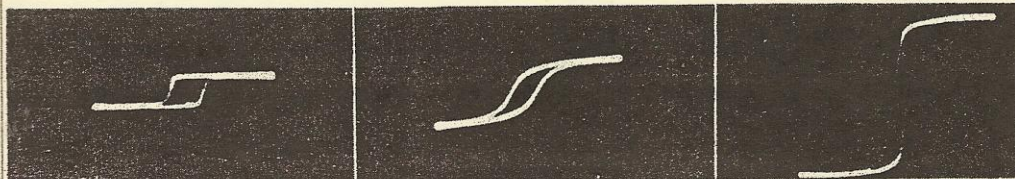

FERRAMIC 34, TYPE A

FERRAMIC 90, TYPE B

FERRAMIC 156, TYPE C

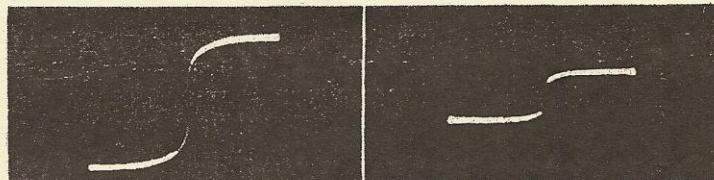

FERRAMIC 146, TYPE D

FERRAMIC 141, TYPE E

38. oscillogram traces of hysteresis loops of five types of ferrites

magnetic amplifiers

Figure 42 shows a basic sketch of a rather interesting magnetic amplifier development recently disclosed by Dr. Robert A. Ramey of Naval Research Lab.

This approach to the magnetic amplifier problem has resulted from the recognition that

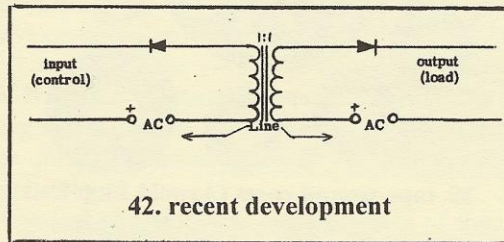

the amplifier is a voltage-sensitive device and not, as generally believed, a current-sensitive device. The only truly independent variable is the control voltage.

The remarkable fact that the time of response of this series amplifier does not depend on the inductance of the transformers as reactors seems to be adequately shown by analysis.

A preliminary view indicates that this amplifier may have the following advantages:

1. Response time is constant, independent of gain. (Always less than one cycle of supply frequency.)
3. Lighter and smaller for the same power output.
4. The output is a linear function of control voltage.
5. Greater power sensitivity. The control source need not supply power to the amplifier control. Power is absorbed instead.
6. Relatively independent of variations in supply voltages.
7. Single-core reactors may be used with little reaction into the control winding.

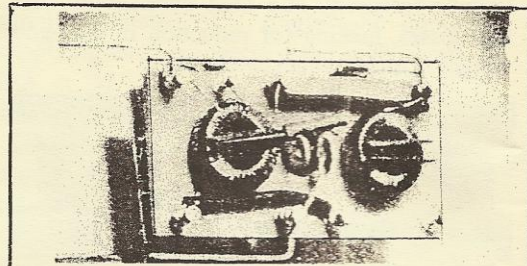

41. trouble-proof magnetic binaries replace vacuum tubes in digital computers

Editor's Insert

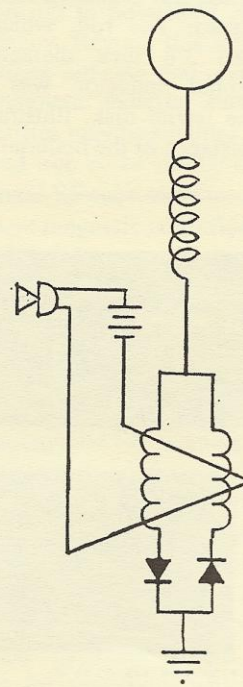

magnetic amplifier modulates Tesla coil

6. Applications

The unreliability of current electronic equipment is a very serious problem, and the electron tube is the largest single factor in equipment failure. The electron tube accounts for more than 50% of circuit failures. An analysis on service calls over an eight week period showed 72% of the breakdowns were due to tube failures. In commercial aircraft 70% of equipment failures are due to tube faults.

Submarine engineers were among the first to appreciate this device for its reliability. Practically everything that moves in a submarine is being studied with a view to possible actuation by static controls. Relays subject to failure due to dust or sticking contacts are being replaced with magnetic amplifiers. Aviation engineers are considering magnetic amplifier controls in many locations previously dominated by relay mechanisms. In these applications, the unreliability and fire hazard of a relay have always been a consideration. Atomic energy engineers are also specifying magnetic amplifier controls in many critical positions where a breakdown could cause astronomical losses in time and material once a reduction process has been started. In one application, single units capable of controlling currents up to 150,000 amperes are being installed.

Here is a summary of suggested applications:

Amplifiers. Both a.c. or d.c. for current, voltage, and power. Amplification gains of several millions can be realized without the

use of electron tubes (but with rather long time constants). This is an excellent d.c. amplifier.

Regulators (most common use) for control of voltage, current, and frequency of industrial power installations, ship main propulsion and auxiliary units; aircraft, automotive electrical equipment, line-to-line voltage regulators independent of frequency.

Relays. The substitution of these units for mechanical relays should be considered for equipment used in humid climates and where there could be explosion hazard from sparking contacts.

Saturable reactor, lighting control, variable impedance, etc. Single units are currently used to control up to 50,000 KVA.

Motor-starter, electric-welding, and automatic battery-charging control. The effectiveness and sensitivity of regulating controls are considerably increased by the addition of a non-linear device such as a thyratron or glow tube which can be connected to effectively amplify the error or act as a reference source itself.

Current limiting reactors. Limiting power currents during short circuits. Limiting armature currents during slow motion or static conditions in follow-up motors.

Servo systems can use magnetic amplifiers as regulators, converters, computers, and as a complete replacement for thyratron and rotary magnetic amplifier (amplidyne) system, at less cost and weight.

Instrument amplifiers, remote control, etc.

magnetic amplifiers

Synchronizer for automatic pulse and frequency control.

Differentiation systems for course plotters and predictors. (example: direct integration from DECCA, RAYDIST, LORAC, and RADUK-II phase-comparison meters to graphic course plotters), constant-speed controls for surveying, wire drag, mine laying, convoys, etc.

Automatic stabilizers and automatic pilots for submarine and aircraft. Alternating current power supply systems for aircraft are well established, making saturable reactor control extremely attractive.

Impulse storing and memory devices.

Timers. Timing pulse generator for radar and loran equipment, wave-shaping, etc. (currently produced with frequency range between 25 cycles and 1 megacycle.)

Electrical computers. Add subtract, multiply, divide, differentiate, or integrate electrical quantities.

Converters, inverters Another method of converting d.c. to a.c. at both 60 and 400 cycles.

Oscillators within limited frequency range.

Phase shifters. Reactance control to $\frac{1}{4}$ cycle,

currently used as phase shifters in grid control of mercury arc rectifiers and in pulse-delay matching circuits in radar equipment.

Fuel pump reactor drives in locations where sparks from relay starting and control contacts could cause an explosion.

Modulators. Voice frequency modulators and radio-frequency carrier trigger circuits. Frequency shift keyers, etc.

Frequency multipliers and reducers, including telephone tone and ringing circuits up to radio frequency.

Seismograph and magnetometer amps: tide gauge, anticipator, audio gain sequence circuits. Drift difficulties are reduced when this device is substituted for tubes.

Multivibrators: one-shot and free-running

Sweep generators: trigger and pulse-forming circuits for radar and loran..

Counters and dividers for loran, shoran, and radar indicators,

Mine and submarine detectors

Field control for magnetic fluid clutches and magnetic-powder brakes. One manufacturer has replaced the regular d.c. charging generator on an experimental bus with a 400-cycle unit.

For More Information

The zealous authors of *Magnetic Amplifiers* provided in the original an exhaustive **Bibliography** with citations from 624 BC(!) to 1950, including hundreds of patents, technical papers, etc. This compendium, disproportionately large (it comprises forty percent of the original book) lends itself to separate publication. A reprint is available from High Voltage Press for \$7.75.

Nuvotem is among a handful of manufacturers still in the mag-amp biz that a search of the internet turned up. Nuvotem makes mag-amp toroids for regulators: <http://Ireland.iol.ie/~nuvotem>.

Ferrite rods: Alltronics (408)943-9773
rectifier diodes: 2 to 30-amp, up to 400 PRV from Mouser (800-346-6873); 6 amp, 50 PRV and 3-amp, 50-1000 PRV from Radio Shack.

High Voltage Press Catalog

What is a 3rd-generation Tesla coil? What is a magnetic amplifier? What is the true wireless?

by George Trinkaus:

Tesla Coil. How Tesla built it. How you can from off-the-shelf parts. Electric energy magnifiers, free energy, beer-bottle capacitor. Lots of background. 26 illustrations. ISBN 0-9709618-0-4 \$7.75

Son of Tesla Coil. Sequel to the classic. Utilitarian Tesla, build a Tesla lighting plant, solid-state drivers, oil magic, home power, 3rd generation Tesla coils. 37 illustrations. ISBN 0-9709618-1-2 \$7.75

Tesla: The Lost Inventions. Disk-turbine rotary engine, magnifying transmitter, wireless power, high-frequency lighting, free-energy receiver. 42 illus., many Tesla patents. ISBN 0-9709618-2-0 \$7.75

Radio Tesla. Who owns the ether? Powerful elemental radio devices, spark reconsidered, grounding rediscovered, low frequency revived, underground radio, license-free radio, carrier current. 66 illustrations. ISBN 0-9709618-3-9 \$7.75

Tesla: The True Wireless. Authored by Tesla (1919), ed. by Trinkaus. Tesla's final public statement on the issue. How radio, at the radical, really works. What ionosphere? Everything you know is wrong. Reset and redesigned. 21 illustrations. ISBN 0-9709618-4-7 \$7.75

Magnetic Amplifiers. Another lost technology. By the U.S. Navy (1951), ed. by Trinkaus. This facile, rugged device was going to replace the vacuum tube in all functions up to a MHz. Completely reset and redesigned. 43 illus. ISBN 0-9709618-5-5 \$7.75

Magnetic Amplifiers Bibliography. A supplement to *Magnetic Amplifiers*. 500 citations of patents, journal articles, institute proceedings, military documents, etc. ISBN 0-9709618-6-3 \$7.75

any title \$7.75 complete set \$39.95

Add for postage and handling: \$1.75 for first title, 75 cents each additional. (Outside USA, double that.)

High Voltage Press, P.O. Box 1525, Portland, OR 97207, USA; 877-263-1215

www.teslapress.com

\$7.75

“Electronics engineers are now forced to concede recognition of the magnetic amplifier, as it has demonstrated its value beyond question in many fields previously dominated by electron tubes.”

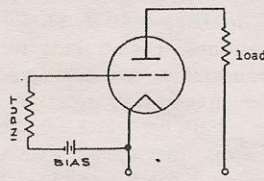

TUBE AMPLIFIER
Fig. 27

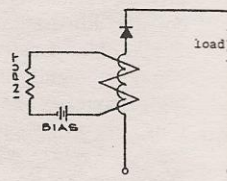

MAGNETIC AMPLIFIER
Fig. 28

Magnetic Amplifiers
ISBN 0-9709618-5-5



High Voltage Press
P.O. Box 1525
Portland, OR
97207 USA
toll-free: 877-263-1215

www.teslapress.com